



INSTALLATION INSTRUCTIONS

Accessory
CROSS BARS
P/N 08L04-TX4-200

Application
2015 RDX

Publications No.
BII 51212
Issue Date
MARCH 2014

PARTS LIST

Front cross bar (long)

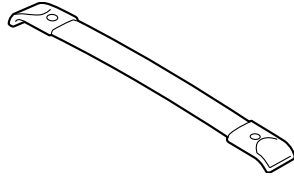

Rear cross bar (short)

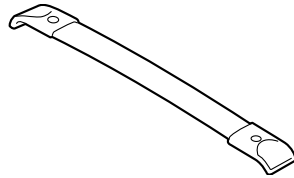

4 Special bolts

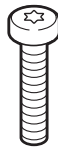

2 Right holders (Marked R)

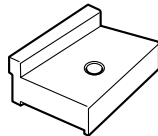

2 Left holders (Marked L)

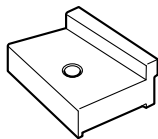

4 Washers



4 Spring washers



TOOLS AND SUPPLIES REQUIRED

T-30 TORX driver
Small flat-tip screwdriver
Torque wrench

Illustration of the Cross Bars on the Vehicle

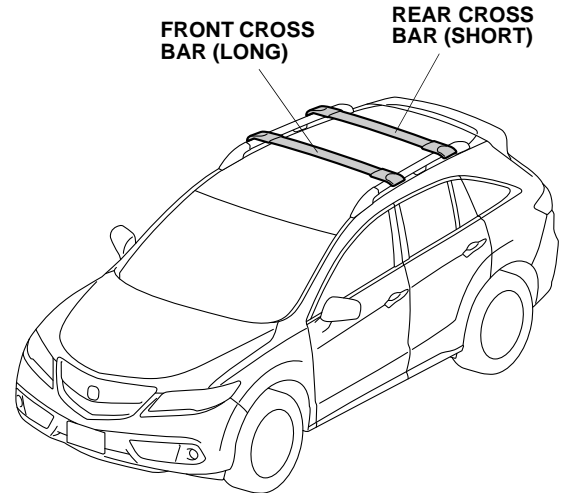

INSTALLATION

Client Information: The information in this installation instruction is intended for use only by skilled technicians who have the proper tools, equipment, and training to correctly and safely add equipment to your vehicle. These procedures should not be attempted by "do-it-yourselfers."

NOTE:

- The cargo weight must not exceed the maximum weight capacity of 50 kg (110 lbs).
- Do not damage the roof and other finished surfaces of the body when installing the cross bars.
- Do not interchange the front and rear parts or the right and left parts.

- Using a small flat-tip screwdriver, remove the rear cover from the roof left rail (three retaining tabs).

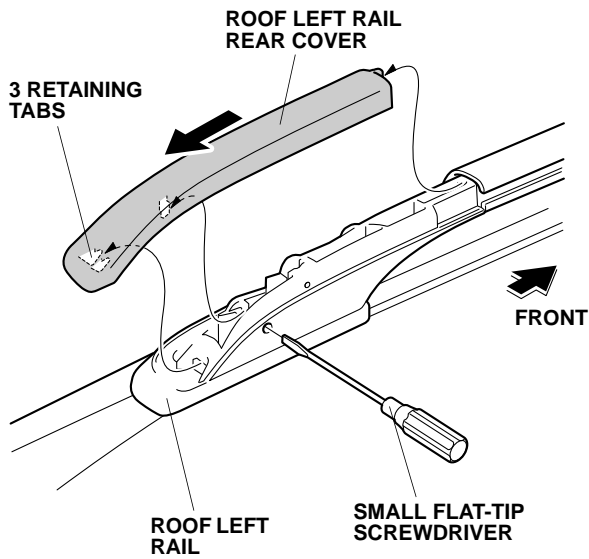

- Repeat step 1 to remove the rear cover from the roof right rail.
- Slide the two left holders and the two right holders into the roof left rail and roof right rail in the direction shown.

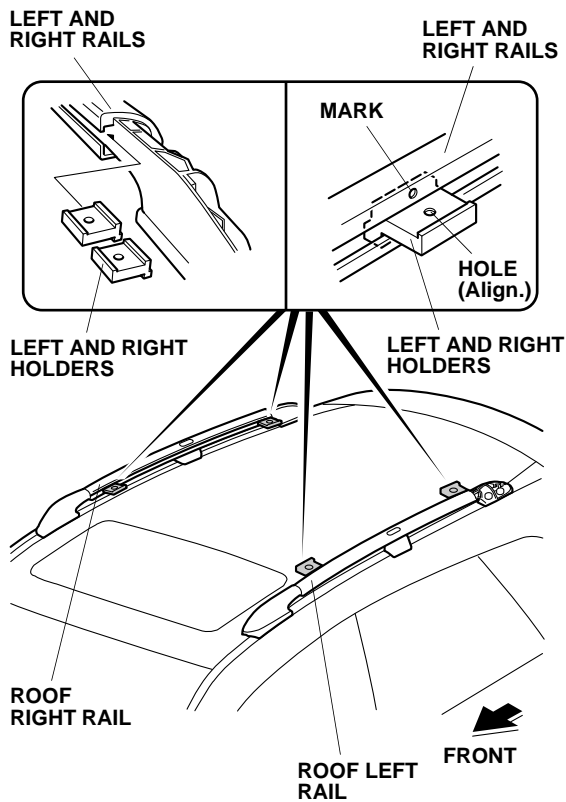

- Align the hole in each holder with the mark on the inside of the roof rail.

- Install the front cross bar (long) and rear cross bar (short) onto the holders with four special bolts, four spring washers, and four washers. Make sure the cross bars are installed in the correct positions and orientation. Torque the special bolts to 7.0 N-m (5.1 lbf-ft).

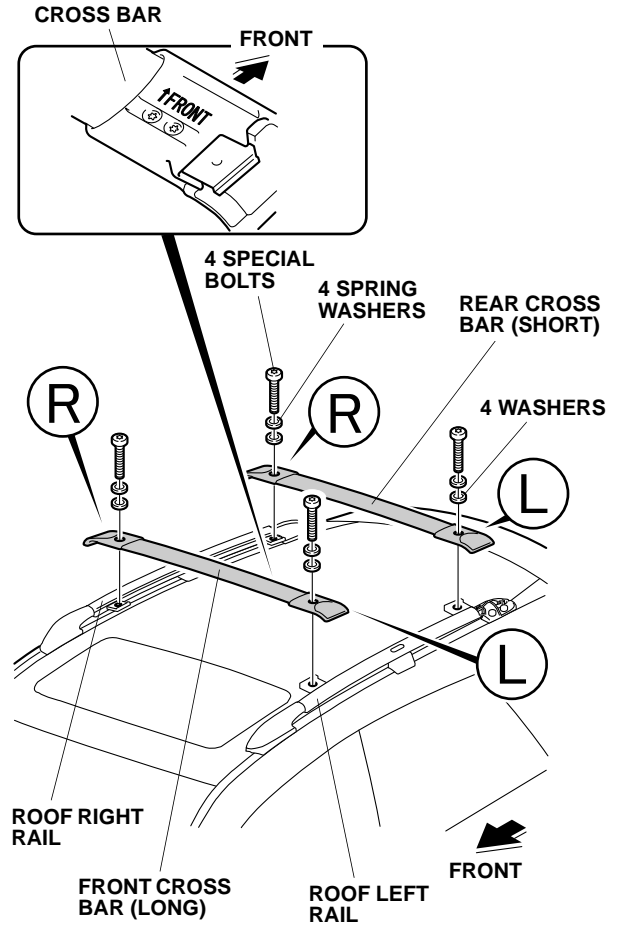

6. Reinstall the rear cover onto the roof left rail with three retaining tabs.

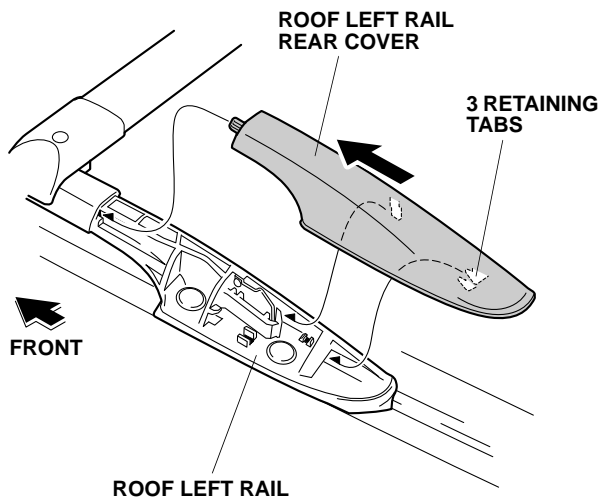

7. Repeat step 6 to reinstall the rear cover onto the right rail.
8. After installation, move the covers back and forth to verify that they are installed securely.

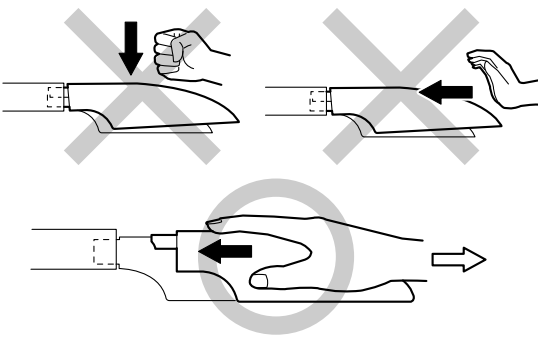

USE AND CARE

- Check the roof rail mounting bolts frequently, and re-tighten if necessary.
- Distribute the weight of the cargo evenly, and do not exceed the maximum weight capacity of 50 kg (110 lbs).